

ECO-FLEX M (RAST 5) Messerleiste in THT-Einlöttechnik für senkrecht Stecken, mit versetztem Rastloch im Kontakt
 ECO-FLEX M (RAST 5) Tab connectors in THT soldering technology for vertical connections, with staggered locking feature at contact

Raster: / pitch: 5mm	Identifikator: / identification: MSVV_9407-006_A_KF	Blatt: / page: A
-------------------------	--	---------------------

Fehlende Maße und Hinweise siehe separate Kundenzeichnung
 Missing dimensions and notes see separate customer drawing

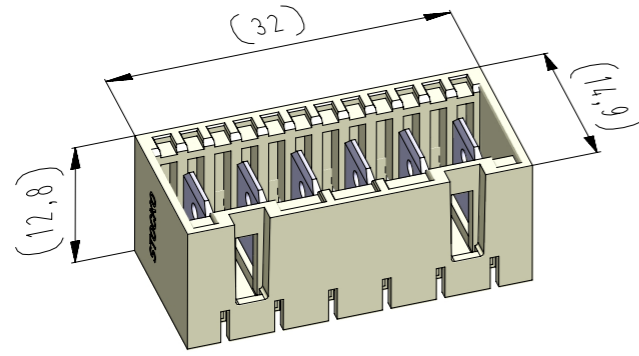

STOCKO CONTACT
 GmbH & Co. KG

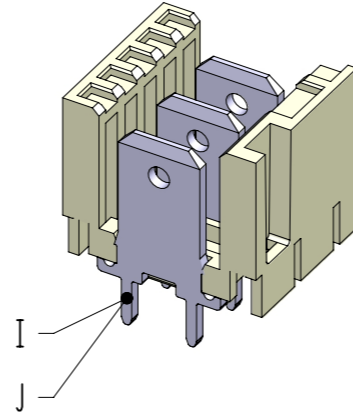
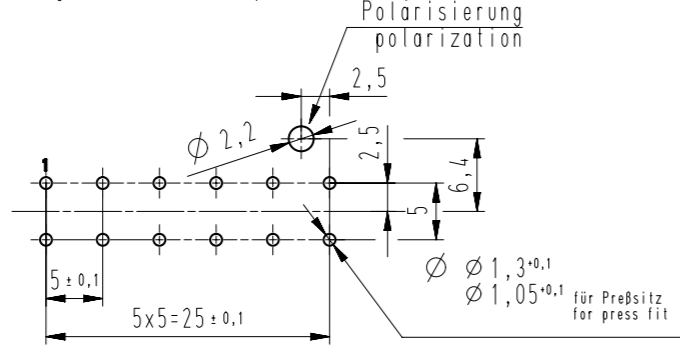

Lochbild (Bestückungsseite) / hole pattern (component side)

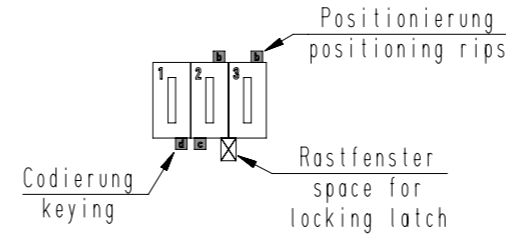

vereinfachte Darstellung einer möglichen Abart
 simplified representation of possible variation



Beispiel Artikelbezeichnung :
 example part description :
MSVV 9407-006-W28-CCC-MMM-NN

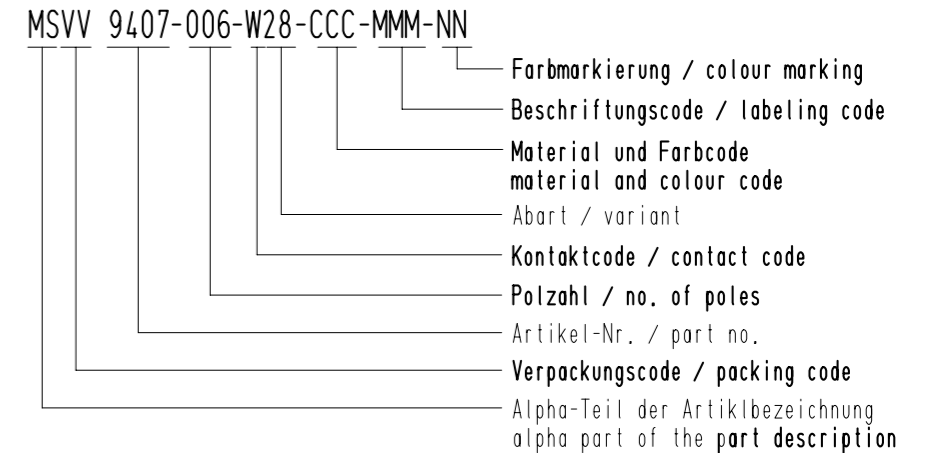

Artikelbezeichnung part description	Anzahl der Kontakte number of contacts	Bestückung / loading						Codierungsvariante siehe Tabelle coding peg variant see chart MH 8420-006	Rastfenster zwischen den Kammern space for locking latch between chambers Bemerkung / remark						
		1	2	3	4	5	6		1	2	3	4	5	6	
MSVV 9407-006-028-CCC-MMM-NN	6	I	I	I	I	I	I	28	X	X	X				
MSVV 9407-006-037-CCC-MMM-NN	6	I	I	I	I	I	I	37	X	X	X	X			
MSVV 9407-006-061-CCC-MMM-NN	6	I	I	I	I	I	I	61	X	X	X				
MSVV 9407-006-02D-CCC-MMM-NN	6	I	I	I	I	I	I	2D	X	X	X				
MSVV 9407-006-02P-CCC-MMM-NN	6	I	I	I	I	I	I	2P	X	X	X				

Artikelbezeichnung part description	Anzahl der Kontakte number of contacts	Bestückung / loading						Codierungsvariante siehe Tabelle coding peg variant see chart MH 8420-006	Rastfenster zwischen den Kammern space for locking latch between chambers Bemerkung / remark						
		1	2	3	4	5	6		1	2	3	4	5	6	

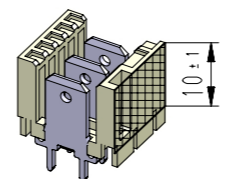

Farbkennzeichnungsbereich bei versilberten Kontakten
 colour coding area when silvered contacts
 (nach / according WN 30.70 Bereich / area "D")

-VV-		
Verpackungscode / packing code		
VV	Verpackungsart / packaging	Bemerkung remark
LO	lose, geschüttet slack pouring	WN 50.202
EM	Einzelmagazine single magazine	WN 50.202

-W-			
Kontaktcode / contact code			
W	Kontakt Artikel-Nr. contact part no.	Material material	Veredelung plating
0	I = RM 6137.051 P 0,8-6,3	CuZn	Sn
1	J = RM 6137.011 P 0,8-6,3	CuZn	Ag

-CCC-			
Material und Farbcode material and colour code			
Materialinformation siehe Kundenzeichnung material data see customer drawing			
Leergehäuse / housing: MH 9401			
Code-Nr. code no.	Farbe colour	Code-Nr. code no.	Farbe colour
118	zinkgelb / zinc yellow	960	natur / nature
121	ropsgelb / rope yellow		
314	altrosa / antique pink		
512	lichtblau / light blue		
518	türkisblau / turquoise blue		
605	moosgrün / moos green		
701	silbergrau / silver grey		
905	schwarz / black		
960	natur / nature		

-MMM-		
Beschriftungscode nach Kundenwunsch labeling code acc. to the customer		
Code-Nr. code no.	siehe WN see WN	Farbe colour
000	-----	ohne Beschriftung without labeling
S**	30.76	Standard / standard

-NN-		
Code-Nr. für Farbmarkierung siehe WN 30.83 code no. for colour marking see WN 30.83		
Code-Nr. / code no.	Farbe / colour	
00	ohne / without	

10	Material WN 14.0634.01 mit Materialcode -960- hinzu.	04.03.22	U0013643
9	Material und Farbcode 627, 715, 721 ungültig und 121 hinzu	11.09.20	U0013643
index	Änderung / modification		Name name
	Datum date	Name name	Projektleiter project manager
erstellt prepared	19.02.09	U0013643	D.M.
			MSVV 9407-006